

Prefeitura Municipal de Itatira
134
~

1 PLANTA

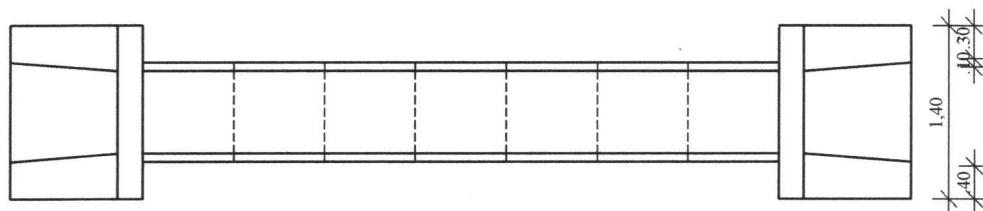

2 CORTE

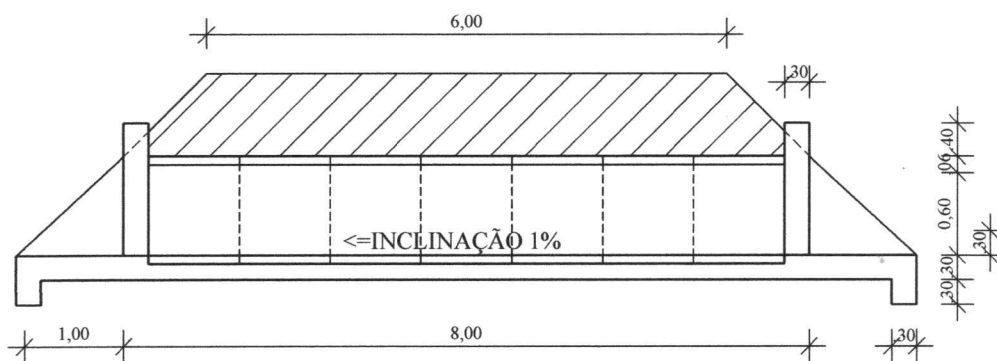

4 VISTA FRONTAL

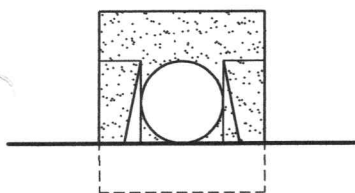

PREFEITURA MUNICIPAL DE ITATIRA

PROJETO:

PIÇARRAMENTO EM ESTRADAS VICINAIS

LOCALIDADE:

LAGOA DE DENTRO, S.GONÇALO, ALEGRE E BR-020
ITATIRA-CE

DATA:

20.05.2020

ESCALA:

H=1:1500
V=1:150

ASSUNTO:

BSTC - BUEIRO SIMPLES TUBULAR DE CONCRETO - Ø=0,8m

PROJETO:



Narcis de Melo Júnior
CREA: 0607557370

PRACHA:

02

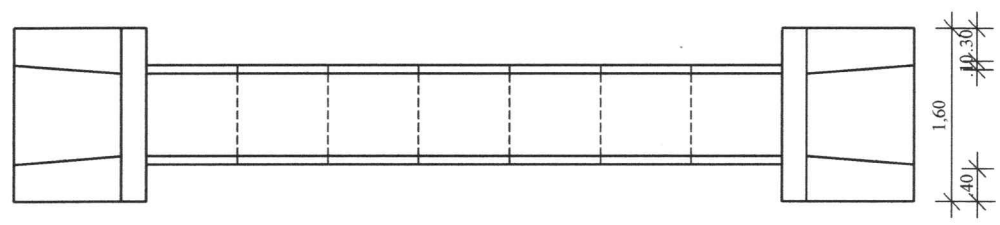

1 PLANTA



2 CORTE

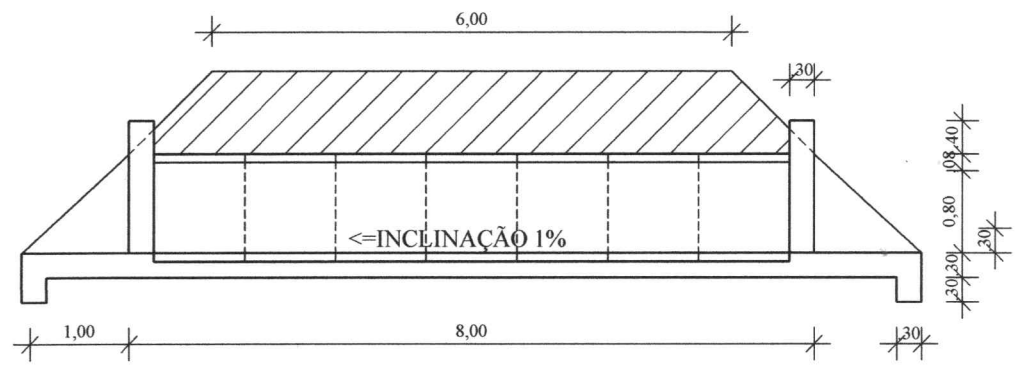

4 VISTA FRONTAL

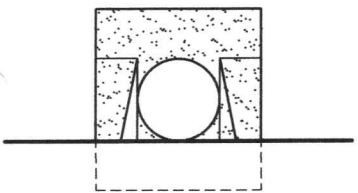

PREFEITURA MUNICIPAL DE ITATIRA

PROJETO:
PIÇARRAMENTO EM ESTRADAS VICINAIS

LOCALIDADE:
LAGOA DE DENTRO, S.GONÇALO, ALEGRE E BR-020
ITATIRA-CE

DATA:
20.05.2020

ESCALA:
H=1:1500
V=1:150

ASSUNTO:
BSTC - BUEIRO SIMPLES TUBULAR DE CONCRETO - Ø=0,8m

PROJETO:

Narci de Melo Júnior
CREA: 0607557370

PRACHA:
03



1 PLANTA

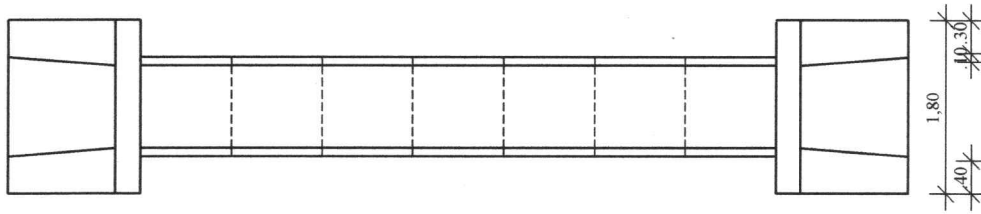

2 CORTE

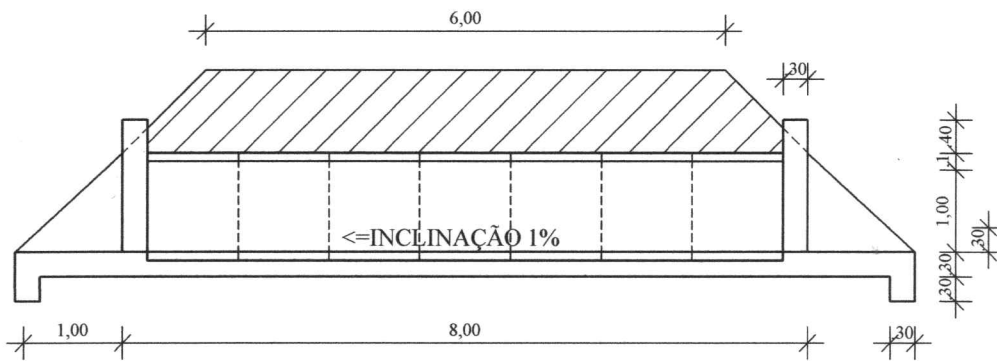

4 VISTA FRONTAL

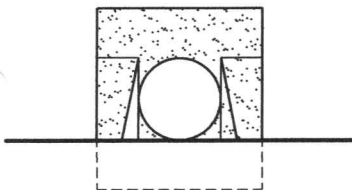

PREFEITURA MUNICIPAL DE ITATIRA

PROJETO:

PIÇARRAMENTO EM ESTRADAS VICINAIS

LOCALIDADE:

LAGOA DE DENTRO, S.GONÇALO, ALEGRE E BR-020
ITATIRA-CE

DATA:

20.05.2020

ESCALA:

H=1:1500
V=1:150

ASSUNTO:

BSTC - BUEIRO SIMPLES TUBULAR DE CONCRETO - $\varnothing=1,0m$

PROJETO:

Narci de Melo Júnior
CREA: 0607557370

PRACHA:

04

1 PLANTA

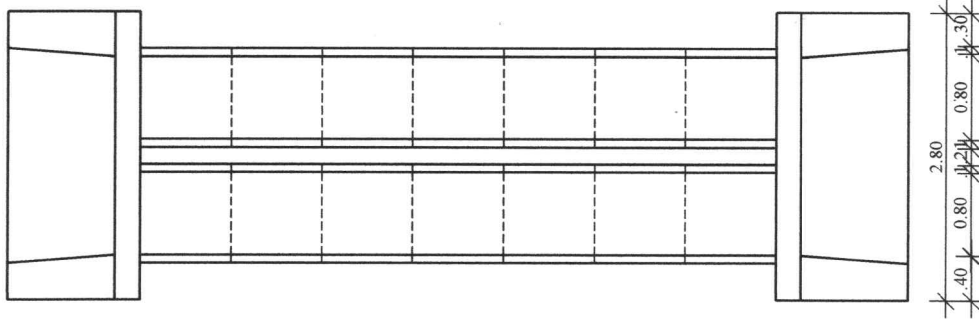

2 CORTE

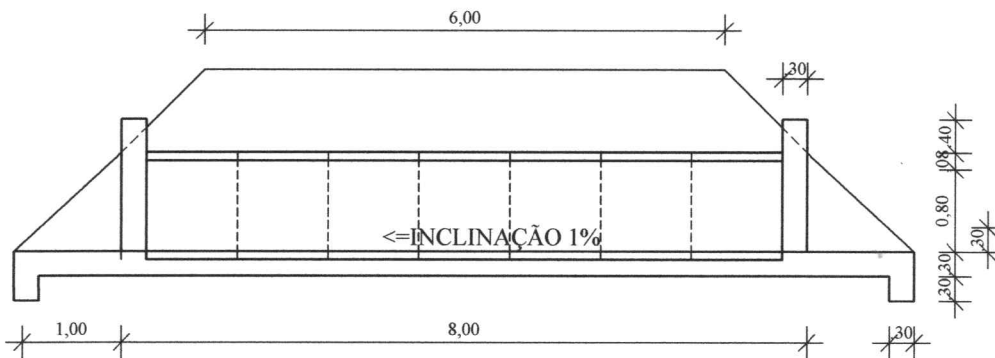

4 VISTA FRONTAL

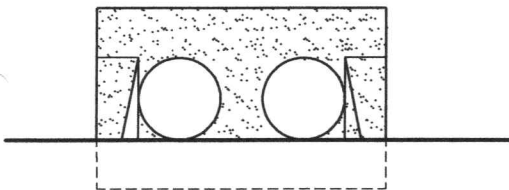

PREFEITURA MUNICIPAL DE ITATIRA

PROJETO:

PIÇARRAMENTO EM ESTRADAS VICINAIS

LOCALIDADE:

LAGOA DE DENTRO, S.GONÇALO, ALEGRE E BR-020
ITATIRA-CE

DATA:

20.05.2020

ESCALA:

H=1:1500
V=1:150

ASSUNTO:

BBTC - BUEIRO DUPLO TUBULAR DE CONCRETO - Ø=1,0m

PROJETO:

Narci de Melo Júnior
CREA: 0607557370

PRACHA:

05

1 PLANTA

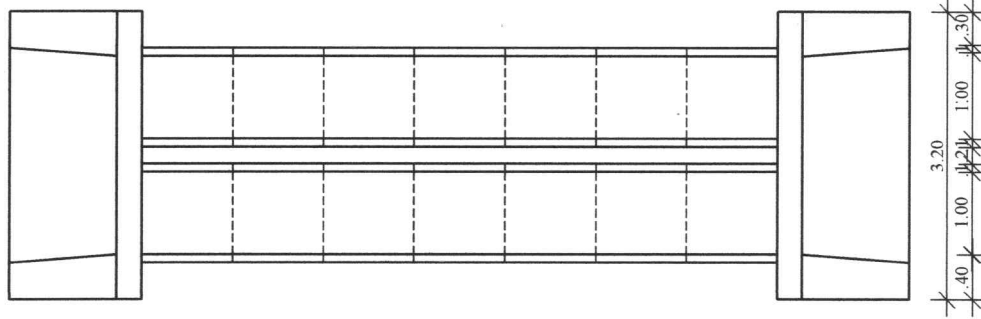

2 CORTE

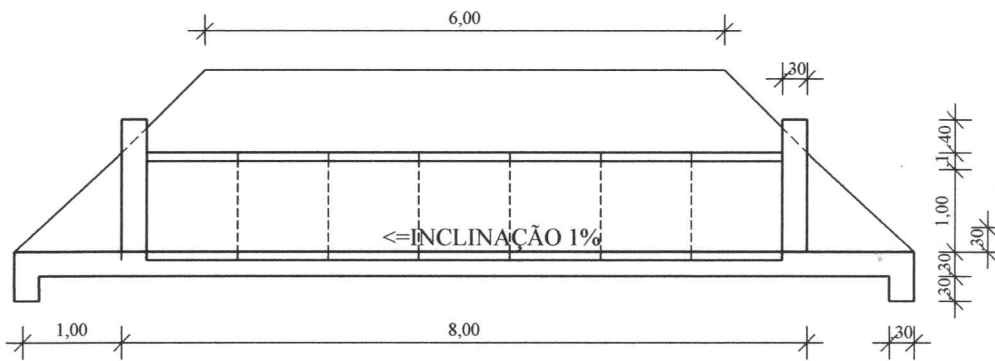

4 VISTA FRONTAL

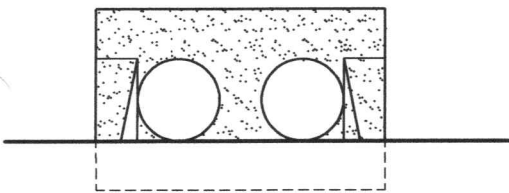

PREFEITURA MUNICIPAL DE ITATIRA

PROJETO:

PIÇARRAMENTO EM ESTRADAS VICINAIS

LOCALIDADE:

LAGOA DE DENTRO, S.GONÇALO, ALEGRE E BR-020
ITATIRA-CE

DATA:

20.05.2020

ESCALA:

H=1:1500
V=1:150

ASSUNTO:

BDTC - BUEIRO DUPLO TUBULAR DE CONCRETO - Ø=1,0m

PROJETO:





Narcis de Melo Júnior
CREA: 0607557370

PRACHA:

06



LEGENDA:

-  ESTRADA VICINAL A RECUPERAR (PROJETADA)
-  ESTRADA VICINAL EXISTENTE
-  RUA CALÇAMENTADA EXISTENTE
-  ESTRADA ASFALTADA EXISTENTE

**PREFEITURA MUNICIPAL DE
I T A T I R A**

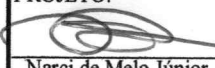
PROJETO: PIÇARRAMENTO EM ESTRADAS VICINAIS		
LOCALIDADE: LAGOA DE DENTRO, S.GONÇALO, ALEGRE E BR-020 ITATIRA-CE	DATA: 10.06.2020	ESCALA: INDICADA
ASSUNTO: PLANTA GERAL DO TRECHO DA ESTRADA	PROJETO:  Narci de Melo Júnior CREA: 0607557370	PIRACHA: 01